

● Description

The KP3020 series consist of two infrared emitting diodes, connected in inverse parallel, optically coupled to a phototransistor detector. They are packaged in an 8-pin DIP package and available in wide-lead spacing and SMD option.

● Features

1. Current transfer ratio
(CTR : Min. 60% at $I_F = \pm 1\text{mA}$ $V_{CE} = 5\text{V}$)
2. High isolation voltage between input and output
(Viso : 5000Vrms)
3. Compact dual-in-line package.
4. AC input
5. Pb free and RoHS compliant
6. Agency Approvals
 - UL1577 / CUL C22.2 No.1 & NTC No.5, File No. E169586
 - VDE EN60747, File No.101347
 - FIMKO EN60065, File No. NCS/FI23149 A2
 - FIMKO EN60950, File No. NCS/FI24584 A1
 - SEMKO EN60065, File No. FI016484
 - SEMKO EN60950, File No. FI016433

● Applications

- System appliances
- Limit Switches
- Sensors
- Programmable controllers applications for Low Input Photocouplers and High Vceo Photocouplers
- Telephone sets
- Telephone exchangers
- Thermostats
- Signal transmission between circuits of different potentials and impedances

● Schematic

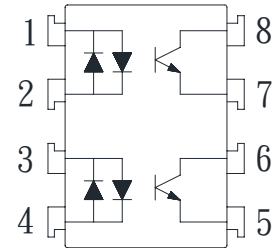

- 1 、 2. Anode, Cathode
- 3 、 4. Anode, Cathode
- 5 、 7. Emitter
- 6 、 8. Collector

● **Outside Dimension**

Unit : mm

1. Dual-in-line type.

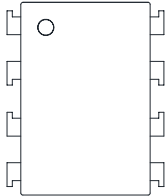

KP3020

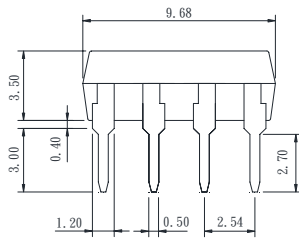
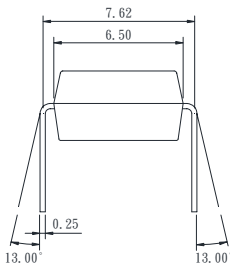

2. Surface mount type.

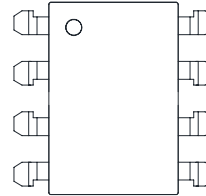

KP3020S

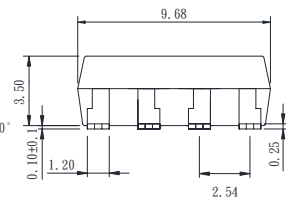
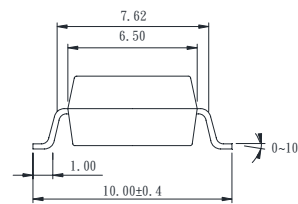

3. Long creepage distance type

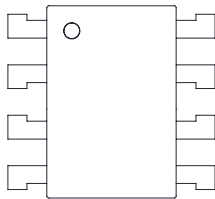

KP3020H

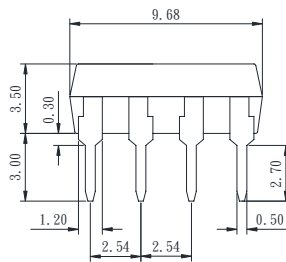
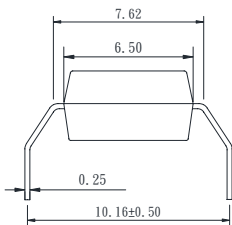

4. Long creepage distance for surface mount type.

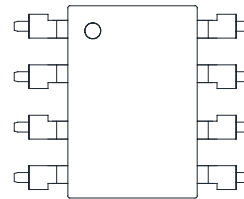

KP3020L

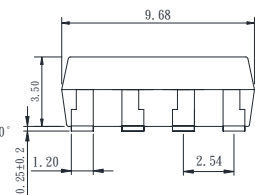
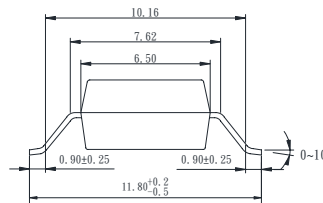

TOLERANCE : ±0.2mm

● **Device Marking**

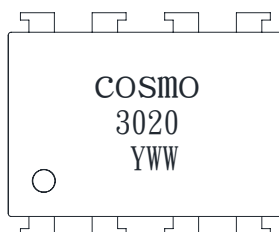

Notes:

COSMO
3020
YWW

Y: Year code / WW: Week code

● Absolute Maximum Ratings

(Ta=25°C)

Parameter		Symbol	Rating	Unit
Input	Forward current	I_F	±50	mA
	Peak forward current	I_{FM}	±1	A
	Power dissipation	P_D	70	mW
Output	Collector-emitter voltage	V_{CEO}	80	V
	Emitter-collector voltage	V_{ECO}	6	V
	Collector current	I_C	50	mA
	Collector power dissipation	P_C	150	mW
Total power dissipation		P_{tot}	200	mW
Isolation voltage 1 minute		V_{iso}	5000	Vrms
Operating temperature		T_{opr}	-55 to +115	°C
Storage temperature		T_{stg}	-55 to +125	°C
Soldering temperature 10 seconds		T_{sol}	260	°C

● Electro-optical Characteristics

(Ta=25°C)

Parameter		Symbol	Conditions	Min.	Typ.	Max.	Unit
Input	Forward voltage	V_F	$I_F=\pm 20\text{mA}$	-	1.2	1.4	V
	Peak forward voltage	V_{FM}	$I_{FM}=\pm 0.5\text{A}$	-	-	3.5	V
	Terminal capacitance	C_t	$V=0, f=1\text{KHz}$	-	30	-	pF
Output	Collector dark current	I_{CEO}	$V_{CE}=20\text{V}$	-	-	0.1	μA
Transfer characteristics	Current transfer ratio	CTR	$I_F=\pm 1\text{mA}, V_{CE}=5\text{V}$	60	-	600	%
	Collector-emitter saturation	$V_{CE(sat)}$	$I_F=\pm 20\text{mA}, I_C=1\text{mA}$	-	0.1	0.3	V
	Isolation resistance	R_{iso}	DC500V	5×10^{10}	10^{11}	-	Ω
	Floating capacitance	C_f	$V=0, f=1\text{MHz}$	-	0.6	1.0	pF
	Cut-off frequency	f_C	$V_{CC}=5\text{V}, I_C=2\text{mA}, R_L=100\Omega$	-	80	-	KHz
	Response time (Rise)	t_r	$V_{CE}=2\text{V}, I_C=2\text{mA}, R_L=100\Omega$	-	5	20	μs
Response time (Fall)	t_f	-		4	20	μs	

Classification table of current transfer ratio is shown below.

KP3020 Model No.	CTR (%)
KP3020 A	60 ~ 600
KP3020 B	60 ~ 300

Fig.1 Current Transfer Ratio vs. Forward Current

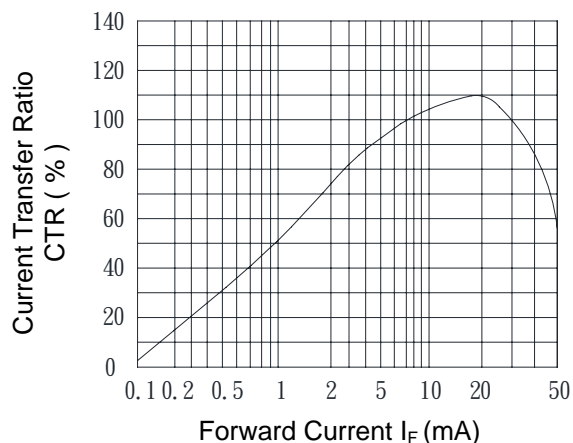

Fig.2 Collector Power Dissipation vs. Ambient Temperature

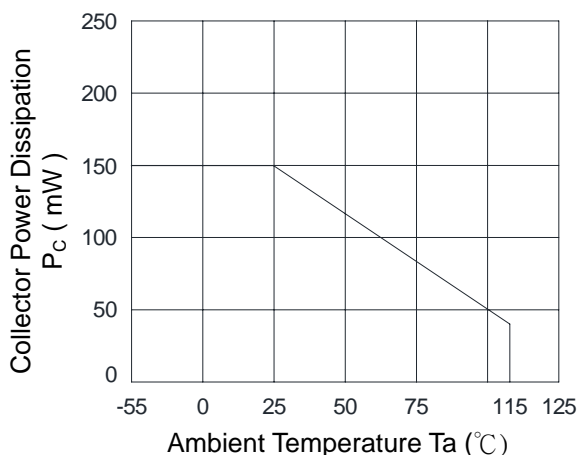

Fig.3 Collector Dark Current vs. Ambient Temperature

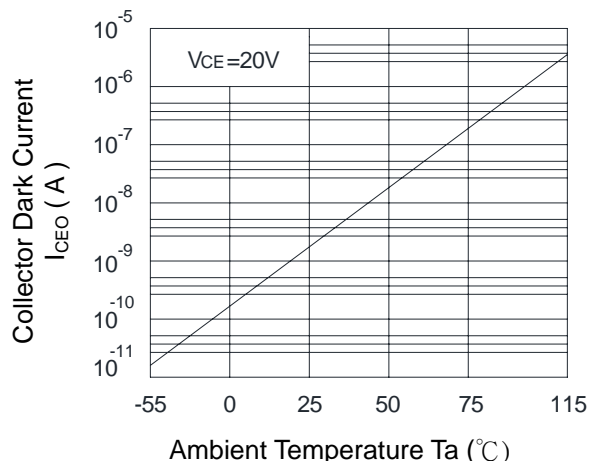

Fig.4 Forward Current vs. Ambient Temperature

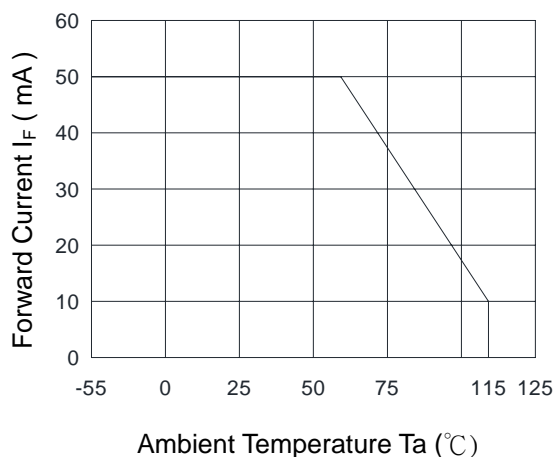

Fig.5 Forward Current vs. Forward Voltage

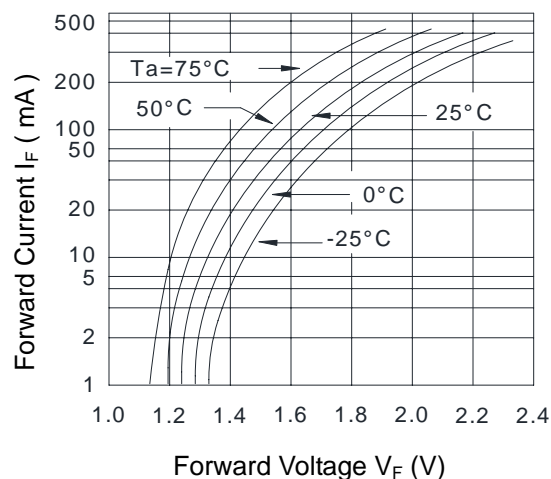

Fig.6 Collector Current vs. Collector-Emitter Voltage

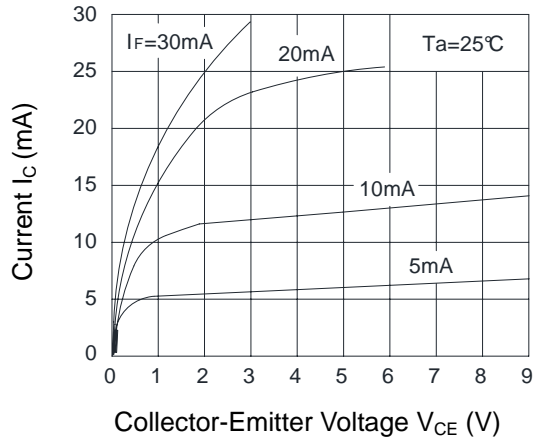

Fig.7 Relative Current Transfer Ratio vs. Ambient Temperature

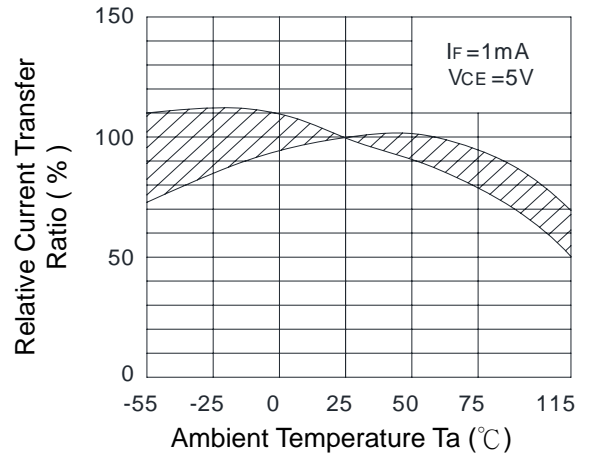

Fig.8 Collector-Emitter Saturation Voltage vs. Ambient Temperature

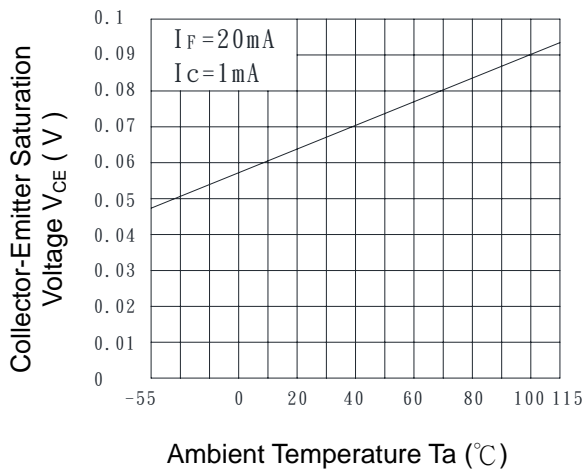

Fig.9 Collector-Emitter Saturation Voltage vs. Forward Current

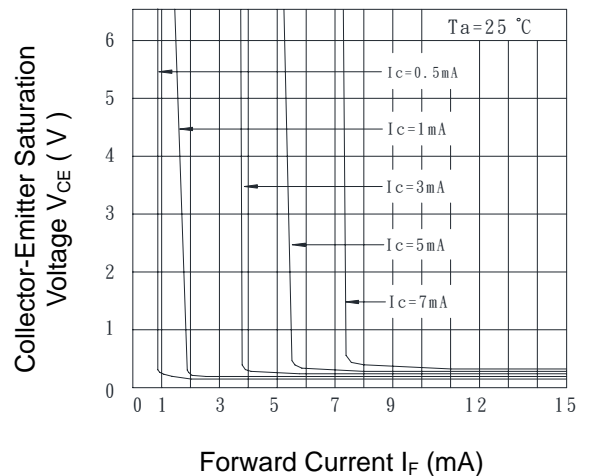

Fig.10 Response Time (Rise) vs. Load Resistance

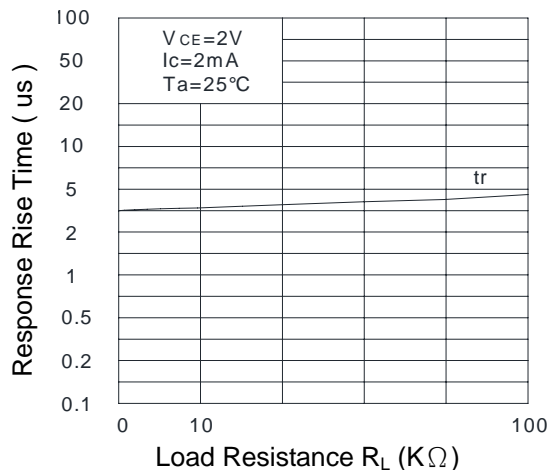
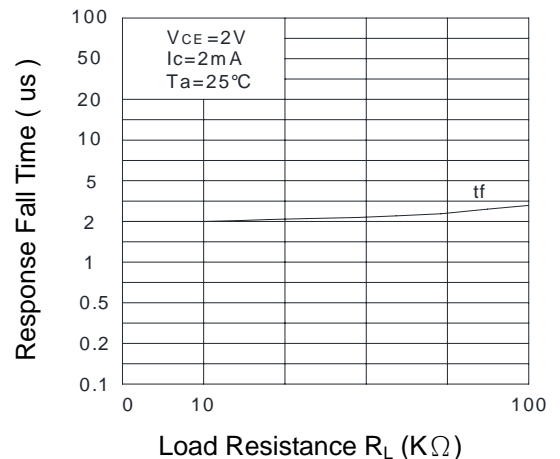
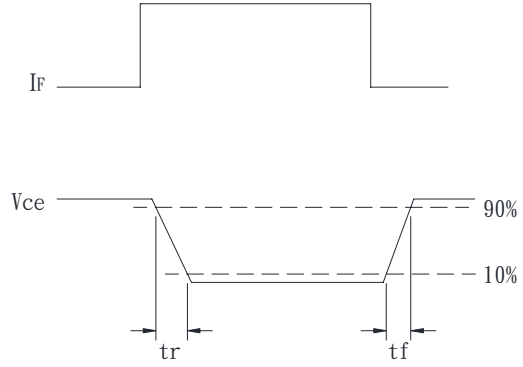
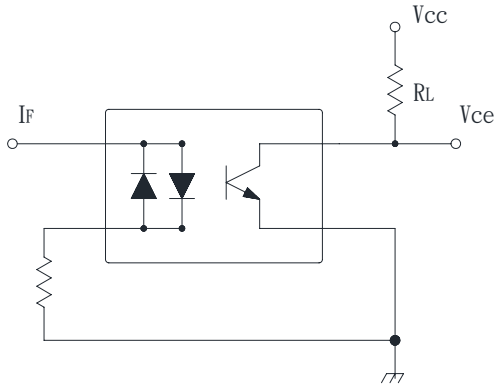

Fig.11 Response Time (Fall) vs. Load Resistance



- **Test Circuit for Response Time**



● Recommended Soldering Conditions

(a) Infrared reflow soldering :

- Peak reflow soldering : 260°C or below (package surface temperature)
- Time of peak reflow temperature : 10 sec
- Time of temperature higher than 230°C : 30-60 sec
- Time to preheat temperature from 180~190°C : 60-120 sec
- Time(s) of reflow : Two
- Flux : Rosin flux containing small amount of chlorine (The flux with a maximum chlorine content of 0.2 Wt% is recommended.)

Recommended Temperature Profile of Infrared Reflow

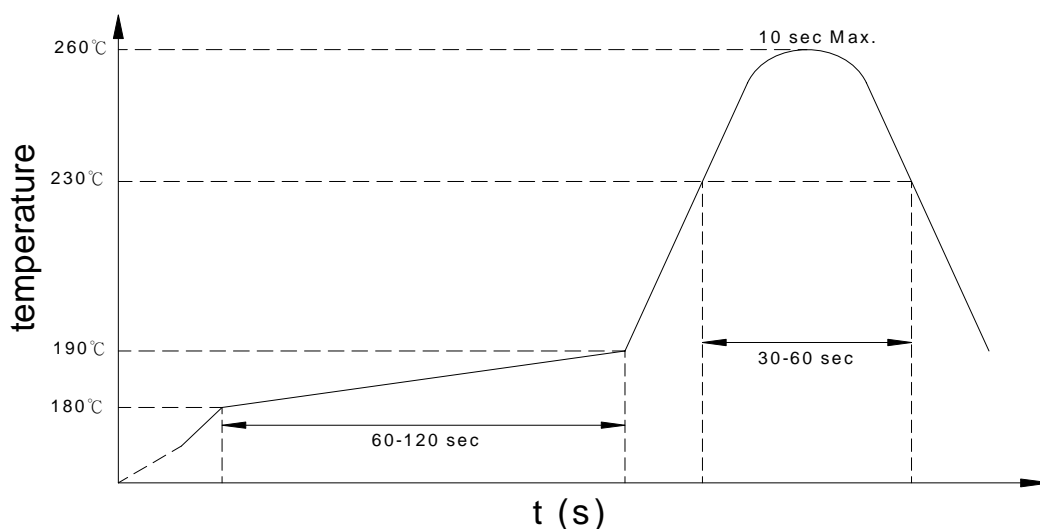

(b) Wave soldering :

- Temperature : 260°C or below (molten solder temperature)
- Time : 10 seconds or less
- Preheating conditions : 120°C or below (package surface temperature)
- Time(s) of reflow : One
- Flux : Rosin flux containing small amount of chlorine (The flux with a maximum chlorine content of 0.2 Wt% is recommended.)

(c) Cautions :

- Fluxes : Avoid removing the residual flux with freon-based and chlorine-based cleaning solvent.
- Avoid shorting between portion of frame and leads.

- **Numbering System**

KP3020 X Y (Z)

Notes:

KP3020 = Part No.

X = Lead form option (0,S,H,L)

Y = CTR rank (A, B)

Z = Tape and reel option (TL,TR,TLD,TRU)

Option	Description	Packing quantity
S (TL)	surface mount type package + TL tape & reel option	1000 units per reel
S (TR)	surface mount type package + TR tape & reel option	1000 units per reel
L (TLD)	long creepage distance for surface mount type package + TLD tape & reel option	1000 units per reel
L (TRU)	long creepage distance for surface mount type package + TRU tape & reel option	1000 units per reel

- **Recommended Pad Layout for Surface Mount Lead Form**

1.Surface mount type.

8 pin SMD

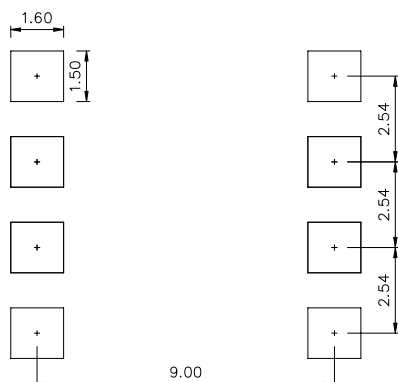
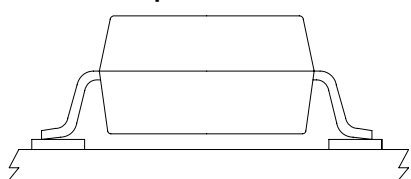

2.Long creepage distance for surface mount type.

8 pin L

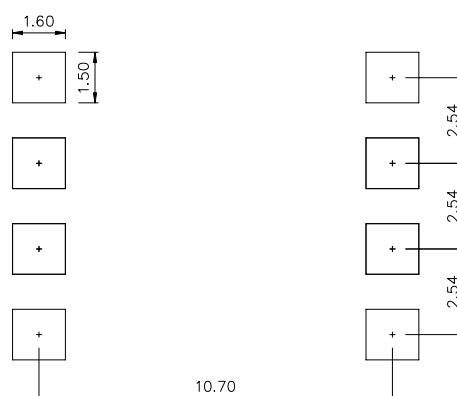
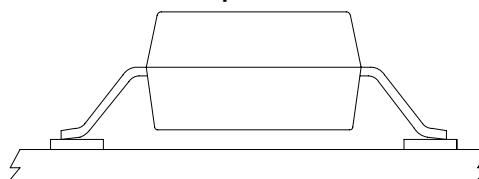

Unit : mm

<http://www.cosmo-ic.com>

● 8-pin SMD Carrier Tape & Reel

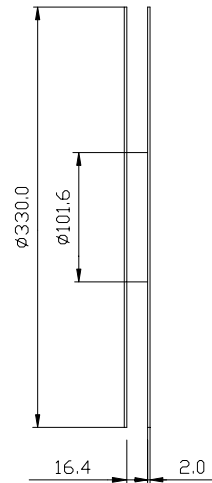
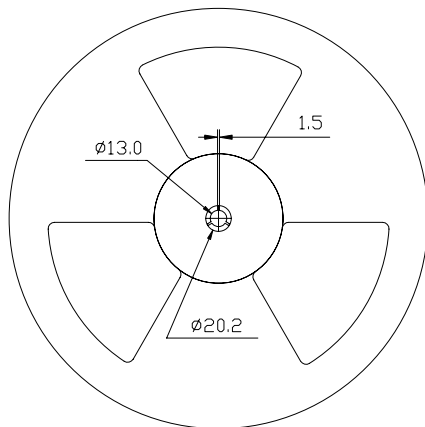
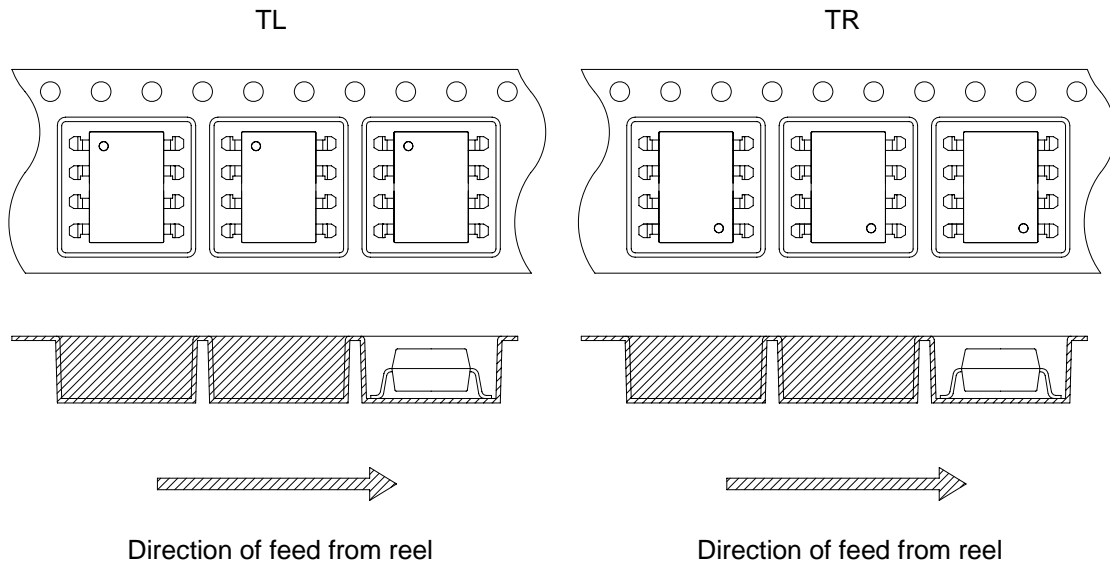
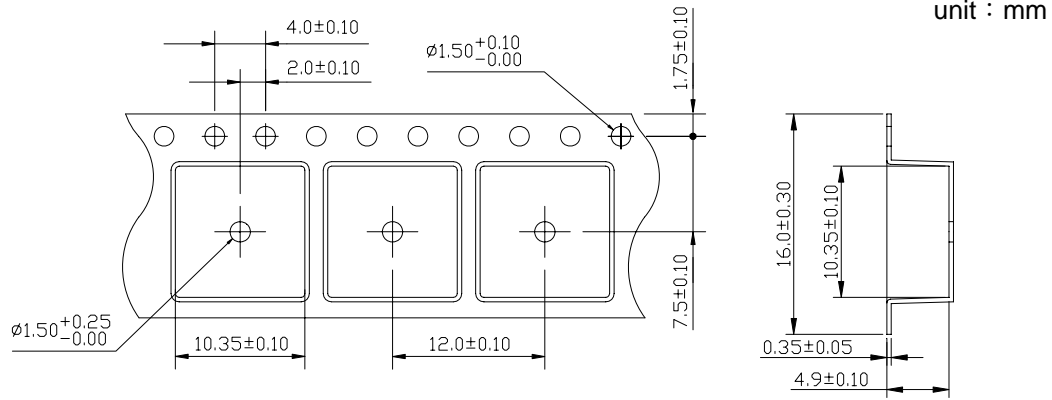

● 8-pin L Carrier Tape & Reel

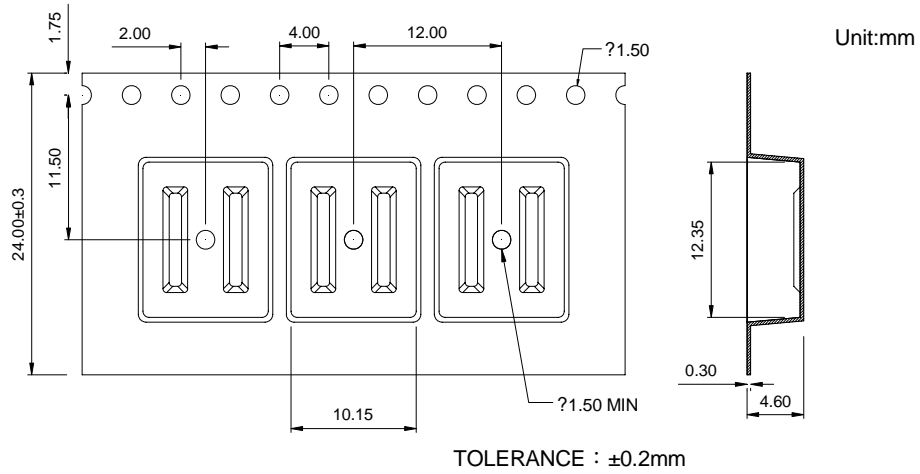

TLD

TRU

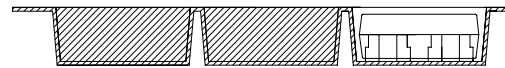
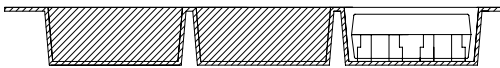
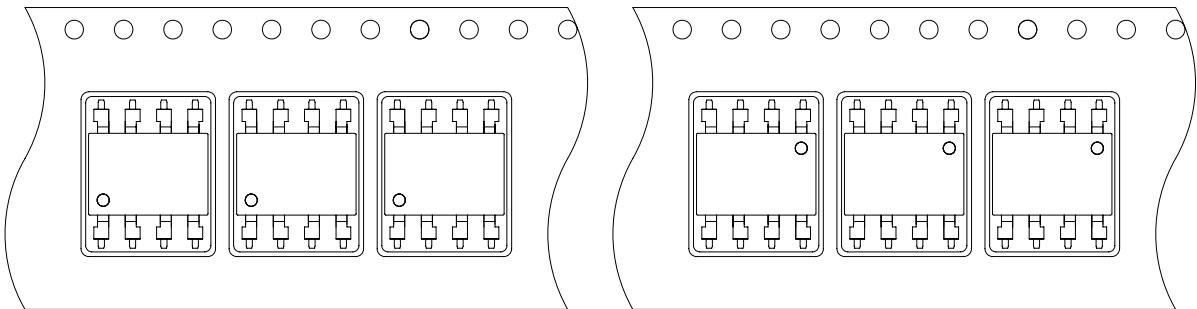

Direction of feed from reel

Direction of feed from reel

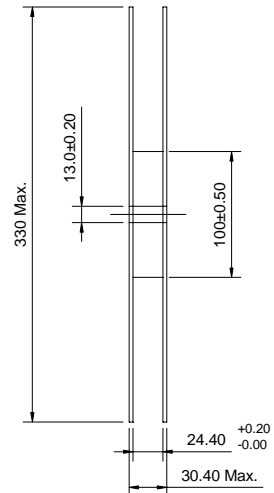
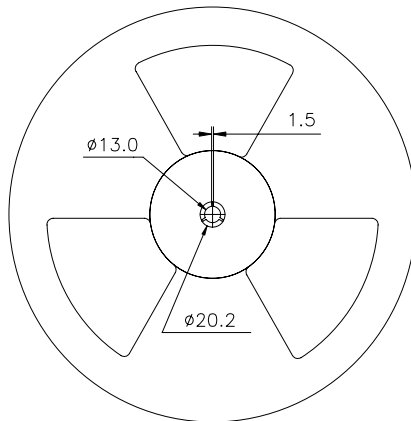

- **Application Notice**

The content of datasheet is the guidance for product use only. cosmo takes no responsibility to the accuracy of the information provided here. For continuously improving all of products, including quality, reliability, function...etc., cosmo reserves the right to change the specification, characteristics, data, materials, and structure of products without notice. Please contact with cosmo to obtain the latest specification.

It would be required to comply with the absolute maximum ratings listed in the specification. cosmo has no liability and responsibility to the damage caused by improper use of the products.

cosmo products are intended to be designed for use in general electronics application list below:

- a. Personal computer
- b. OA machine
- c. Audio / Video
- d. Instrumentation
- e. Electrical application
- f. Measurement equipment
- g. Consumer electronics
- h. Telecommunication

cosmo devices shall not be used or related with equipment requiring higher level of quality / reliability, or malfunction, or failure which may cause loss of human life, bodily injury, includes, without limitation:

- a. Medical and other life supporting equipments
- b. Space application
- c. Telecommunication equipment (trunk lines)
- d. Nuclear power control
- e. Equipment used for automotive vehicles, trains, ships...etc.

This publication is the property of cosmo. No part of this publication may be reproduced or copied in any form or any means electronically or mechanically for any purpose, in whole or in part without any written permission expressed from cosmo.