

3mm Advanced Super Flux LEDs 33-01-C44-RRFC-D1T1U1CH-AM

Lead (Pb) Free Product - RoHS Compliant

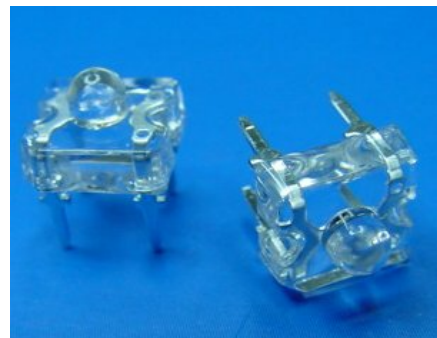

Feature

- Lead-Free
- RoHS compliant.
- Low profile.
- Uniform color
- High flux output
- Colorless clear resin.
- Brightness: 7150 to 14250 mlm at 70mA.
- Qualification according to AEC-Q101.
- Packaged in tubes for use with automatic insertion equipment.
- Compliance with EU REACH.
- Compliance Halogen Free .(Br <900 ppm ,Cl <900 ppm , Br+Cl < 1500 ppm).

Applications

- Automotive lighting
- Electronic Signs and Signals.
- Special Lighting application

Device Selection Guide

LED Part No.	Chip	Emitted Color	Resin Color
	Material		
33-01-C44-RRFC-D1T1U1CH-AM	AlGaInP	Red	Water Clear

Table of Content	Page
Product Nomenclature	3
Absolute Maximum Ratings (Ta=25)	4
Electro-Optical Characteristics (Ta=25)	5
Bin Range of Dominant Wavelength (Ta=25)	6
Bin Range of Forward Voltage (Ta=25)	7
Bin Range of Total Flux (Ta=25)	8
Typical Electro-Optical Characteristics Curves	9
Package Dimensions	11
Inner and Outer Label Explanation	12
Antistatic Packing Materials Tube and Standard Boxes	13
Precautions	14
Revision History	18

Product Nomenclature

33	-	01	-	C5	4	-	RRF	C	-	D1	T1U1	C	H	-	AM
1		2		3	4		5	6		7	8	9	10		11

The product name is designated as below:

1.	Product type
2.	Lead-frame type
3	Angle
4.	Product pasted without Zener
5	Chip code
6.	Resin color
7.	Wavelength
8.	Power &Total Flux
9.	Range of Forward Voltage specification
10.	Operation current
11	Application

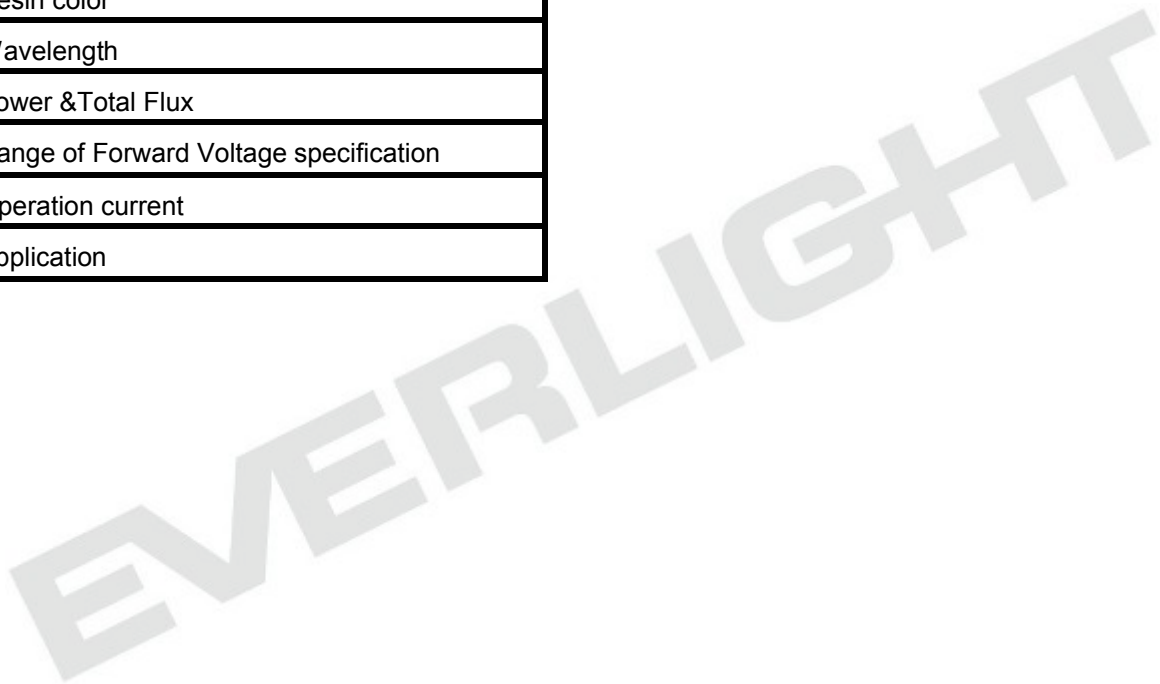

Absolute Maximum Ratings (Ta=25)

Parameter	Symbol	Rating	Unit
Reverse Voltage	V _R	5	V
Continuous Forward Current	I _F	70	mA
Power Dissipation	P _d	220	mW
LED Junction Temperature	T _j	115	
Operating Temperature	T _{opr}	-40 ~ +100	
Storage Temperature	T _{stg}	-40 ~ +110	
Electrostatic Discharge	ESD	2000	V
Soldering Temperature	T _{sol}	Wave Soldering : 260 Hand Soldering : 300	for 5 sec for 3 sec

Electro-Optical Characteristics (Ta=25)

Parameter	Symbol	Min.	Typ.	Max.	Unit	Condition
Total Flux	Φ_V	7150	-----	14250	mlm	$I_F = 70\text{mA}$
Peak Wavelength	λ_p	-----	631	-----	nm	$I_F = 70\text{mA}$
Dominant Wavelength	λ_d	620	-----	628	nm	$I_F = 70\text{mA}$
Spectrum Radiation Bandwidth	$\Delta\lambda$	-----	18	-----	nm	$I_F = 70\text{mA}$
Viewing Angle	$2\theta_{1/2}$	-----	115	-----	deg	$I_F = 70\text{mA}$
Forward Voltage	V_F	1.9	-----	2.9	V	$I_F = 70\text{mA}$
Reverse Current	I_R	-----	-----	10	μA	$V_R = 10\text{V}$

Note:

1. Tolerance of Total Flux: $\pm 11\%$
2. Tolerance of Dominant Wavelength: $\pm 1\text{nm}$
3. Tolerance of Forward Voltage: $\pm 0.1\text{V}$

Bin Range of Dominant Wavelength (Ta=25)

Bin	Min.	Max.	Unit	Condition
2	620	624	nm	I _F =70mA
3	624	628		

Note:

Tolerance of Dominant Wavelength: ±1nm

EVERLIGHT

Bin Range of Forward Voltage ($T_a=25$)

Bin	Min.	Max.	Unit	Condition
2	1.9	2.1	V	$I_F = 70\text{mA}$
3	2.1	2.3		
4	2.3	2.5		
5	2.5	2.7		
6	2.7	2.9		

Note:

Tolerance of Forward Voltage: $\pm 0.1\text{V}$

EVERLIGHT

Bin Range of Total Flux (Ta=25)

Bin	Min.	Max.	Unit	Condition
T1	7150	9000	mlm	I _F =70mA
T2	9000	11250		
U1	11250	14250		

Note:

Tolerance of Total Flux: ±11%

EVERLIGHT

Typical Electro-Optical Characteristics Curves

Typical Curve of Spectral Distribution

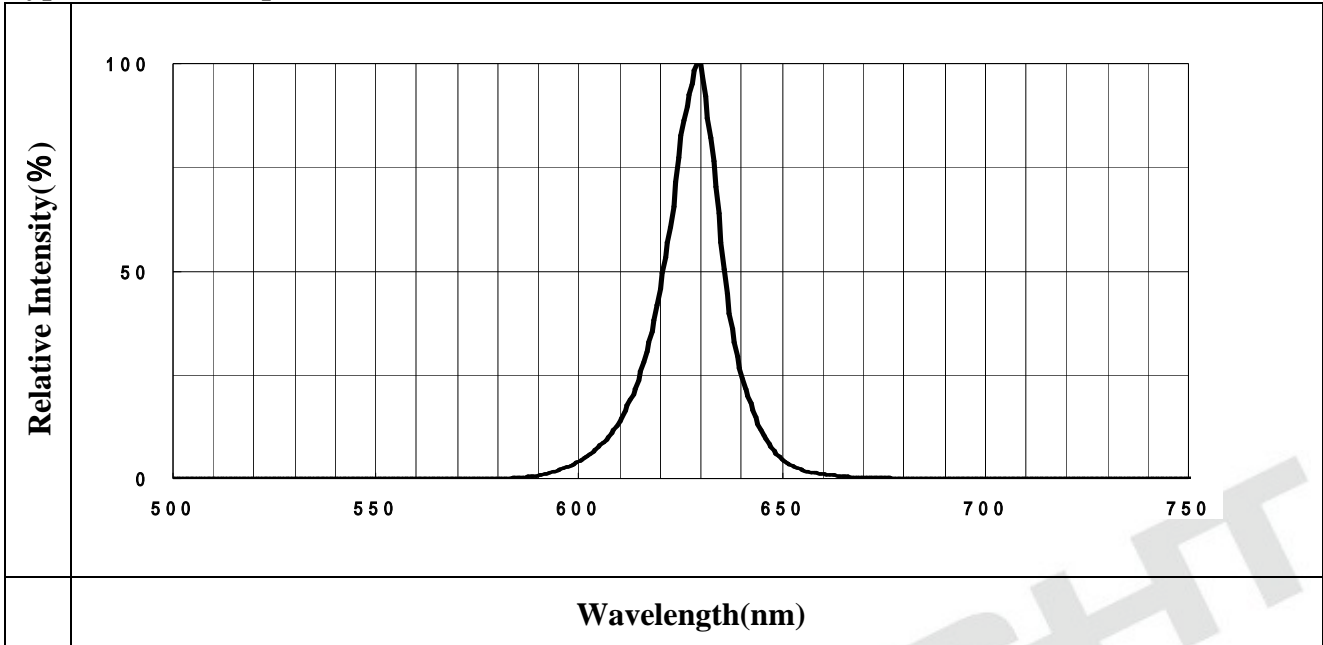
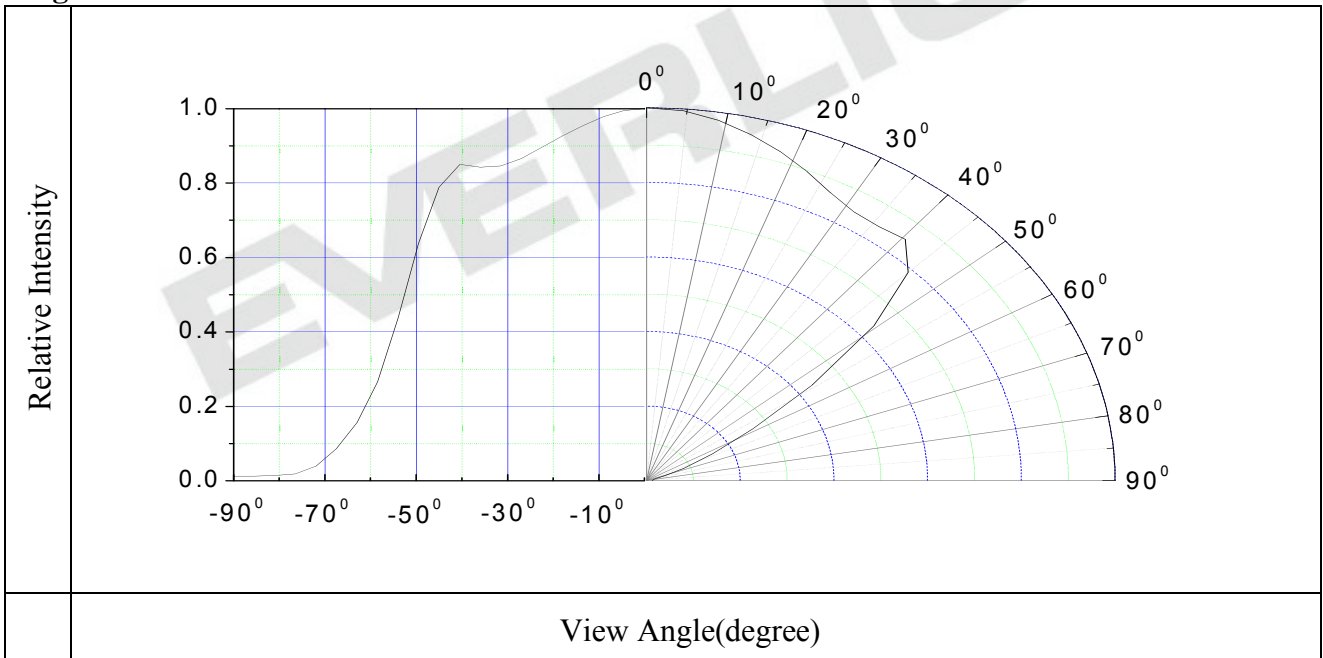
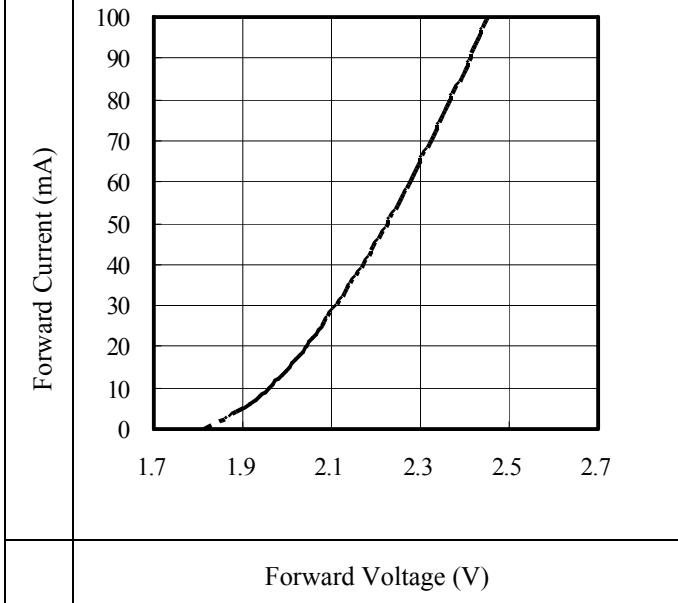

Diagram Characteristics of Radiation



Forward Current vs. Forward Voltage
(Ta=25 °C)



Dominant Wavelength vs. Forward Current
(Ta=25 °C)

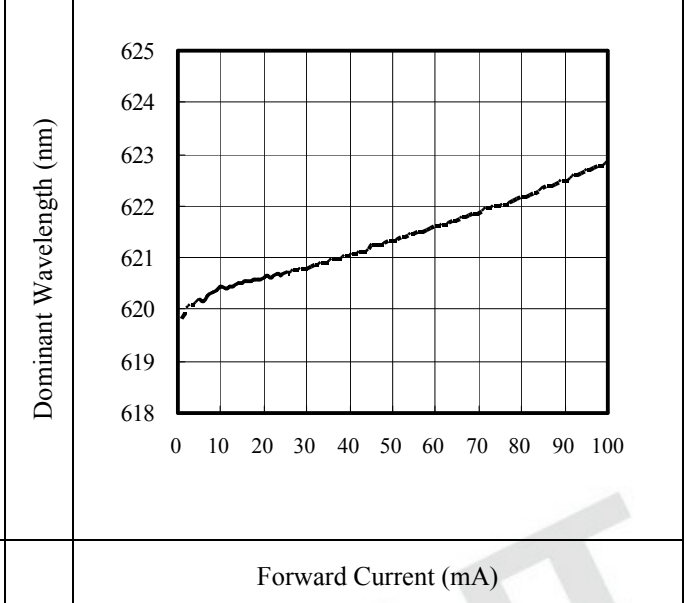

Relative Luminous Intensity vs. Forward Current
(Ta=25 °C)

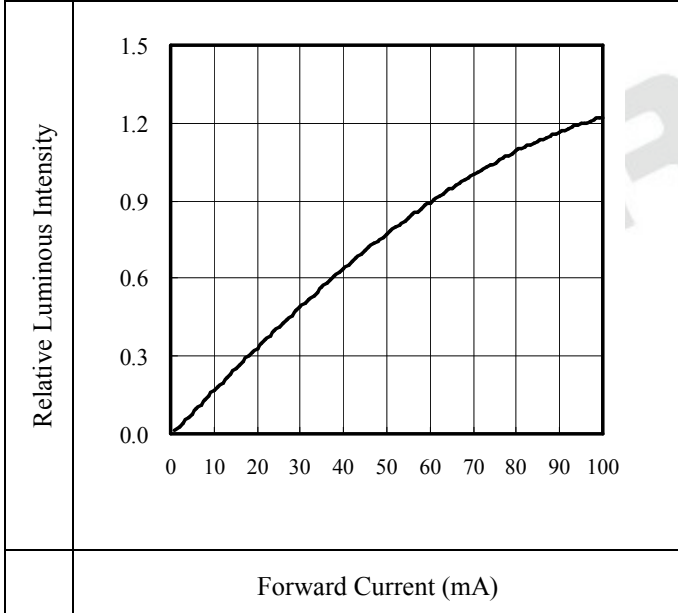

Max. Permissible Forward Current vs. Ambient Temperature

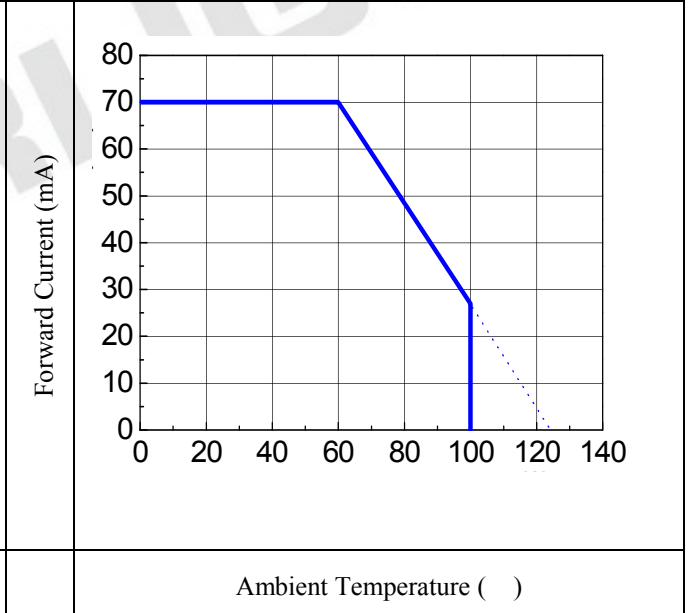

Package Dimension

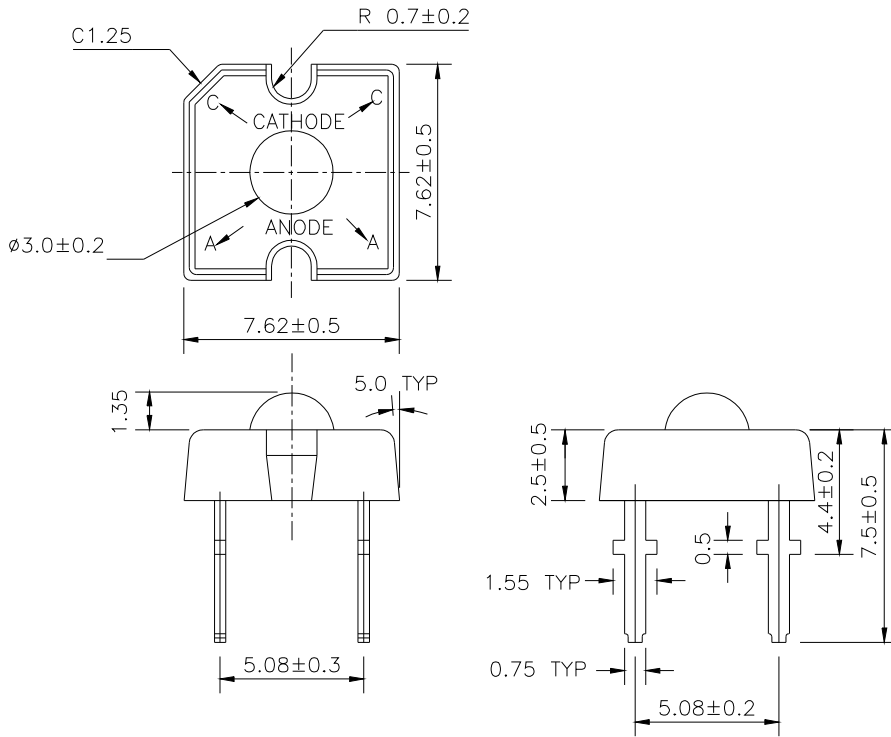

Note: Tolerances unless mentioned ± 0.25 mm. Unit = mm

Inner and Outer Label Explanation

Outer Label Explanation

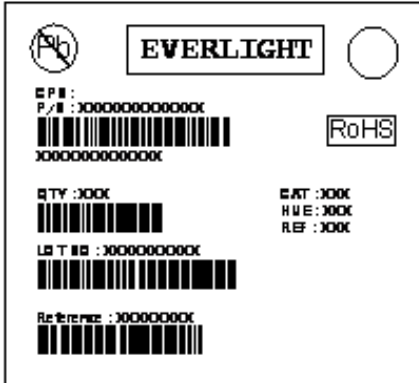

- CPN: Customer's Product Number
- P/N: Product Number
- QTY: Packing Quantity
- CAT: Rank of (VF)(Note*)(ΦV)
- NOTE: λ_d /CIE/Color temperature
- HUE/REF: Reference
- LOT No: Lot Number

Inner Label Explanation

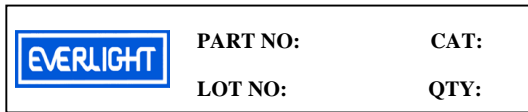

- P/N: Product Number
- QTY: Packing Quantity
- CAT: Rank of (VF)(Note*)(ΦV)
- NOTE: λ_d /CIE/Color temperature
- LOT No: Lot Number

Antistatic Packing Materials Tube

Materials Tube

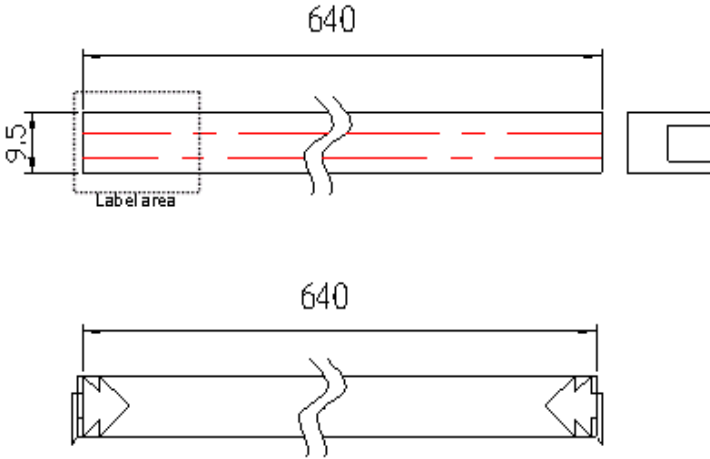

Note:

1. Tolerances unless mentioned $\pm 2.0\text{mm}$.
2. Unit = mm

Standard Boxes

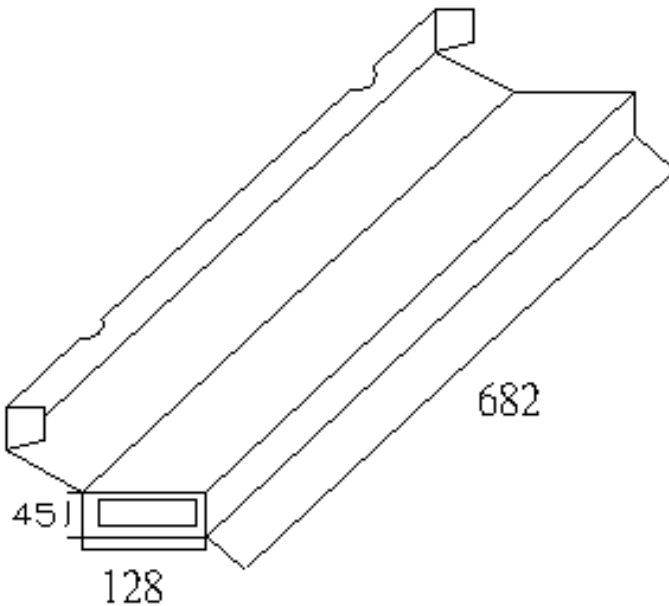

Note:

1. Tolerances unless mentioned $\pm 3.0\text{mm}$.
2. Unit = mm

Precautions for use

1. Lead Forming

- During lead formation, the leads should be bent at a point at least 3mm from the base of the epoxy bulb.
- Lead forming should be done before soldering.
- Avoid stressing the LED package during leads forming. The stress to the base may damage the LED's characteristics or it may break the LEDs.
- Cut the LED leadframes at room temperature. Cutting the leadframes at high temperatures may cause failure of the LEDs.
- When mounting the LEDs onto a PCB, the PCB holes must be aligned exactly with the lead position of the LED. If the LEDs are mounted with stress at the leads, it causes deterioration of the epoxy resin and this will degrade the LEDs.

2. Storage

- The LEDs should be stored at 30°C or less and 60%RH or less after being shipped from Everlight and the storage life limits are 3 months. If the LEDs are stored for 3 months or more, they can be stored for a year in a sealed container with a nitrogen atmosphere and moisture absorbent material.
- Please avoid rapid transitions in ambient temperature, especially, in high humidity environments where condensation can occur.

3. Soldering

- Careful attention should be paid during soldering. Solder the LED no lower than 1.6mm from the base of stopper is recommended.
- Avoiding applying any stress to the lead frame while the LEDs are at high temperature particularly when soldering.
- Recommended soldering conditions:

Hand Soldering		DIP Soldering	
Temp. at tip of iron	300 Max. (30W Max.)	Preheat temp.	100 Max. (60 sec Max.)
Soldering time	3 sec Max.	Bath temp.	260 Max.
Distance	No lower than 1.6mm from the base of stopper	Bath time.	5 sec Max.
		Distance	No lower than 1.6mm from the base of stopper

- Recommended soldering profile

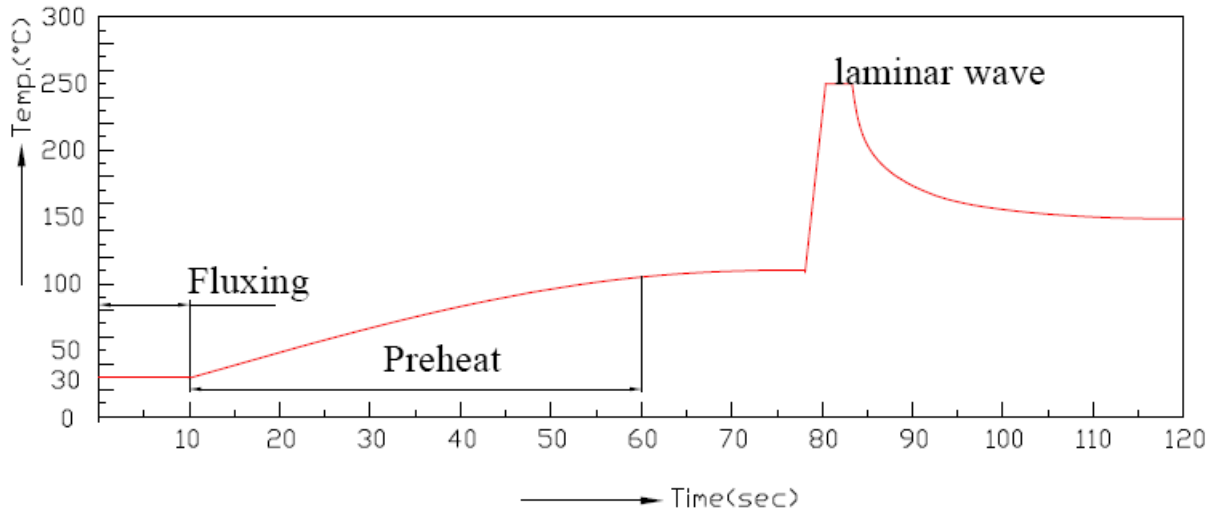

- To avoid any stress to the lead frame while the LEDs are at high temperature particularly when soldering.
- Dip or hand soldering should not be done more than one time.
- The len of LEDs should be protected from mechanical shock or vibration until return to room temperature after soldering.
- Cooling rapidly is not recommended after cold down from peak temperature.
- Dipping parameters must be set and maintain according to recommended range.

4. Cleaning

- Cleaning with isopropyl alcohol should not more than one minute and dry it in room temperature.
- Ultrasonic cleaning is prohibited which may damage the LEDs.

5. Thermal Management

Sufficient thermal management must be implemented. Otherwise, the junction temperature of the die might be over the limit at high current driving condition and LEDs' lifetime might be decreases dramatically.

6. ESD (Electrostatic Discharge)

- The products are sensitive to static electricity or surge voltage. ESD can damage a die and its reliability.

When handling the products, the following measures against electrostatic discharge are strongly recommended:

Eliminating the charge

Grounded wrist strap, ESD footwear, clothes, and floors

Grounded workstation equipment and tools

ESD table/shelf mat made of conductive materials

- Proper grounding is required for all devices, equipment, and machinery used in product assembly. Surge protection should be considered when designing of commercial products.

- If tools or equipment contain insulating materials such as glass or plastic, the following measures against electrostatic discharge are strongly recommended:
 - Dissipating static charge with conductive materials
 - Preventing charge generation with moisture
 - Neutralizing the charge with ionizers

7. Directions for use

- The LEDs should be operated with forward bias. The driving circuit must be designed so that the LEDs are not subjected to forward or reverse voltage while it is off. If reverse voltage is continuously applied to the LEDs, it may cause migration resulting in LED damage

8. Other

- EVERLIGHT assumes no responsibility for any damage resulting from use of the product which does not comply with the absolute maximum ratings and the instructions included in these specification sheets.
- These specification sheets include all the contents are protected under copyright of EVERLIGHT Corporation. Please don't reproduce or cause anyone to reproduce without EVERLIGHT's permission

EVERLIGHT

Application Restrictions

High reliability applications such as military/aerospace, automotive safety/security systems, and medical equipment may require different product. If you have any concerns, please contact Everlight before using this product in your application. This specification guarantees the quality and performance of the product as an individual component. Do not use this product beyond the specification described in this document.

EVERLIGHT

Revision History

Rev.	Modified date	File modified contents
1	2009/9/1	New Spec.
2	2013/5/24	Change to the form of datasheet
3	2014/2/25	Change the size of the packaging carton
4	2014/7/11	Change the packing specification

EVERLIGHT