

HF68F (JQX-68F)

MINIATURE HIGH POWER RELAY



File No.:E134517



File No.:129371



File No.:CQC02001001945



Features

- Low height 12.3 mm
- 8A switching capability
- 5kV dielectric strength (between coil and contacts)
- Creepage distance >8mm
- Wash tight and flux proofed types available
- Environmental friendly product (RoHS compliant)
- Outline Dimensions: (28.5 x 10.1 x 12.3) mm

CONTACT DATA

Contact arrangement	1A, 1C
Contact resistance	100mΩ (at 1A 6VDC)
Contact material	See ordering info.
Contact rating (Res. load)	8A 250VAC/30VDC
Max. switching voltage	440VAC / 125VDC
Max. switching current	10A
Max. switching power	2000VA / 240W (at 0.5HP 250VAC)
Mechanical endurance	1 x 10 ⁷ OPS
Electrical endurance	1 x 10 ⁵ OPS (See approval reports for more details)

CHARACTERISTICS

Insulation resistance	1000MΩ (at 500VDC)	
Dielectric strength	Between coil & contacts	5000VAC 1min
	Between open contacts	1000VAC 1min
Surge voltage (between coil & contacts)	10kV (1.2X50μs)	
Operate time (at nomi. volt.)	15ms max.	
Release time (at nomi. volt.)	8ms max.	
Temperature rise (at nomi. volt.)	55K max.	
Humidity	35% to 85% RH	
Ambient temperature	-40°C to 85°C	
Shock resistance	Functional	100m/s ² (10g)
	Destructive	1000m/s ² (100g)
Vibration resistance	10Hz to 500Hz 20g/5g	
Termination	PCB	
Unit weight	Approx. 8.2g	
Construction	Wash tight, Flux proofed	

Notes: The data shown above are initial values.

COIL

Coil power | 5 to 24VDC: 220mW; 48 to 60VDC: 290mW

COIL DATA

at 23°C

Nominal Voltage VDC	Pick-up Voltage VDC	Drop-out Voltage VDC	Max. Allowable Voltage VDC	Coil Resistance Ω
5	3.75	0.50	11.8	113 x (1±10%)
6	4.50	0.60	14.1	164 x (1±10%)
12	9.00	1.20	28.2	620 x (1±10%)
18	13.50	1.80	42.3	1295 x (1±10%)
24	18.00	2.40	56.4	2350 x (1±10%)
48	36.00	4.80	112.8	9600 x (1±15%)
60	45.00	6.00	141.0	12500 x (1±15%)

Notes: The max. allowable voltage in the COIL DATA is coil overdrive voltage, it is the instantaneous max. voltage which the relay coil could endure in a very short time.

SAFETY APPROVAL RATINGS

UL & CUR	AgCdO	8A 250VAC/30VDC 10A/250VAC B300, R300 Pilot duty	
		8A 250VAC/30VDC	
VDE	Specifications		Ratings
	AgCdO	HF68F...1 (H;Z)(S)(G)(F)	8A 250VAC COSØ =1 at 70°C
	AgNi	HF68F...1 (H;Z)(S)(B)(G)(F)	8A 250VAC COSØ =1 at 85°C 5A 400VAC COSØ =1 at 85°C
	AgSnO ₂	HF68F...1 (H;Z)(S)(T)(G)(F)	8A 250VAC COSØ =1 at 85°C 10A/4A 250VAC COSØ =1 at 50°C

Notes: Only some typical ratings are listed above. If more details are required, please contact us.



HONGFA RELAY

ISO9001、ISO/TS16949、ISO14001、OHSAS18001 CERTIFIED

2007 Rev. 2.00

ORDERING INFORMATION

HF68F / 012 -1H S G F (XXX)	
Type ¹⁾	HF68F JQX-68F (Old type)
Coil voltage	5, 6, 12, 18, 24, 48, 60VDC
Contact arrangement	1H: 1 Form A 1Z: 1 Form C
Construction ²⁾	S: Wash tight Nil: Flux proofed
Contact material ³⁾	G: AgCdO+ Au plated T: AgSnO ₂ B: AgNi BG: AgNi+ Au plated Nil: AgCdO
Insulation standard	F: Class F Nil: Class B
Customer special code ⁴⁾ (Only for special requirements)	e.g. (551) stands for RoHS compliant (Cadmium containing contacts) (555) stands for RoHS compliant (Cadmium-free contacts)

Notes: 1) We have now gradually updated our ordering information. We suggest new type should be selected. If necessary, old type can be kept for some period for the old customers.

2) Under the ambience with dangerous gas like H₂S, SO₂ or NO₂, wash tight type is recommended; please test the relay in real applications. If the ambience allows, flux proofed is preferentially recommended.

3) For gold plated type, the min. switching current and min. switching voltage is 10mA 5VDC.

4) HF68F is an environmental friendly product. Please mark a special code (555) or (551) when ordering. (551) stands RoHS compliant with Cadmium contact; (555) stands for RoHS compliant with Cadmium-free contact.

OUTLINE DIMENSIONS, WIRING DIAGRAM AND PC BOARD LAYOUT

Unit: mm

Outline Dimensions

1 Form A (5mm Pinning)

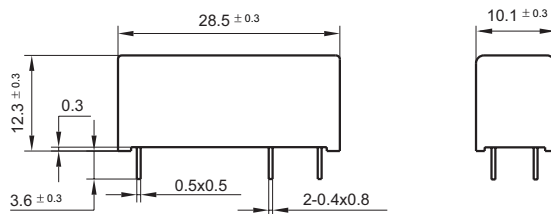

1 Form C (3.2mm Pinning)

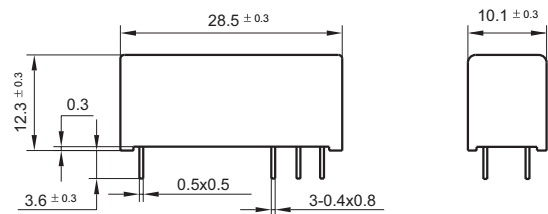

PCB Layout (Bottom view)

1 Form A (5mm Pinning)

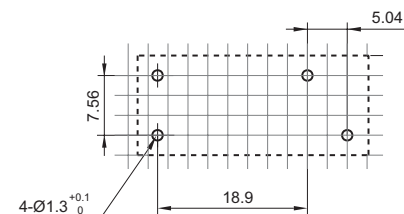

1 Form C (3.2mm Pinning)

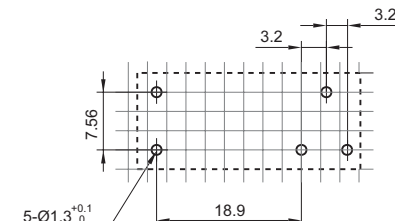

Remark: 1) In case of no tolerance shown in outline dimension: outline dimension ≤ 1 mm, tolerance should be ± 0.2 mm; outline dimension > 1 mm and ≤ 5 mm, tolerance should be ± 0.3 mm; outline dimension > 5 mm, tolerance should be ± 0.4 mm.

2) The tolerance without indicating for PCB layout is always ± 0.1 mm.

3) The width of the gridding is 2.52mm.

Wiring Diagram
(Bottom view)

1 Form A

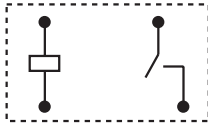

1 Form C

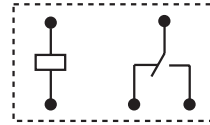

CHARACTERISTIC CURVES

ENDURANCE CURVE

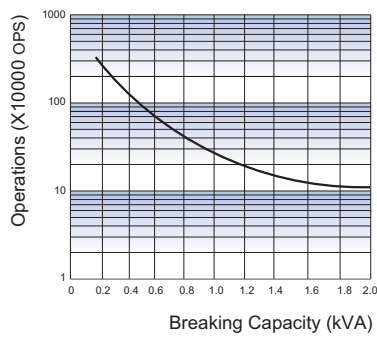

MAXIMUM SWITCHING POWER

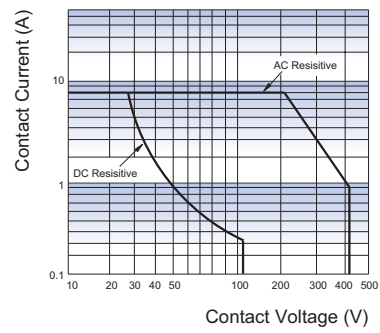

Disclaimer

This datasheet is for the customers' reference. All the specifications are subject to change without notice.

We could not evaluate all the performance and all the parameters for every possible application. Thus the user should be in a right position to choose the suitable product for their own application. If there is any query, please contact Hongfa for the technical service. However, it is the user's responsibility to determine which product should be used only.

© Xiamen Hongfa Electroacoustic Co., Ltd. All rights of Hongfa are reserved.