

FKS Resistor ATO® Style

RoHS











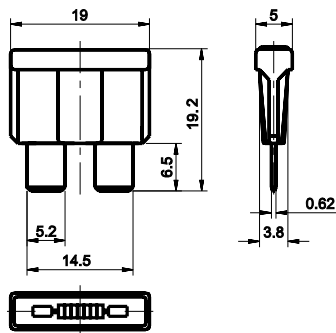

Specifications

Insulating body:	Out of thermoplastic (UL 94-V0, heat-resistant)
Connections:	Blade contacts Copper alloy, gal. Sn Edge-protected
Resistance:	Metal coating resistance 1%, 0.4 W
Packaging unit:	1,000 pieces

ATO-Style FKS-Coding Plug with 0.4 W metal coating resistor 1%. Available resistance 110 Ohms to 9,100 Ohms.

ATO-Style Kodierstecker mit metallisiertem Widerstand (0,4 W, 1%). Erhältlich mit Widerstandswerten von 110 Ohm bis 9.100 Ohm.



Part Number Artikel-Nr.	Resistance Widerstand	Housing Color Kennfarbe	Identification Letter Kennbuchstabe
163.7010.0102	110 Ω		A
163.7010.0152	240 Ω		B
163.7010.0202	430 Ω		C
163.7010.0252	680 Ω		D
163.7010.0302	1,000 Ω		E
163.7010.0352	1,500 Ω		F
163.7010.0402	2,400 Ω		G
163.7010.0452	3,900 Ω		H
163.7010.0502	9,100 Ω		I

Corresponding fuse holders see Section "Fuse Holders."