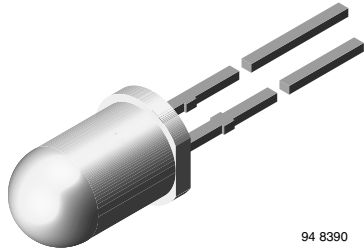


## High Speed Infrared Emitting Diode, RoHS Compliant, 870 nm, GaAIAs Double Hetero



94 8390

### DESCRIPTION

TSFF5210 is an infrared, 870 nm emitting diode in GaAIAs double hetero (DH) technology with high radiant power and high speed, molded in a clear, untinted plastic package.

### FEATURES

- Package type: leaded
- Package form: T-1 3/4
- Dimensions (in mm):  $\varnothing$  5
- Leads with stand-off
- Peak wavelength:  $\lambda_p = 870$  nm
- High reliability
- High radiant power
- High radiant intensity
- Angle of half intensity:  $\varphi = \pm 10^\circ$
- Low forward voltage
- Suitable for high pulse current operation
- High modulation bandwidth:  $f_c = 24$  MHz
- Good spectral matching with Si photodetectors
- Lead (Pb)-free component in accordance with RoHS 2002/95/EC and WEEE 2002/96/EC


**RoHS**  
COMPLIANT

### APPLICATIONS

- Infrared video data transmission between camcorder and TV set
- Free air data transmission systems with high modulation frequencies or high data transmission rate requirements
- Smoke-automatic fire detectors

### PRODUCT SUMMARY

COMPONENT	$I_e$ (mW/sr)	$\varphi$ (deg)	$\lambda_p$ (nm)	$t_r$ (ns)
TSFF5210	180	$\pm 10$	870	15

**Note**

Test conditions see table "Basic Characteristics"

### ORDERING INFORMATION

ORDERING CODE	PACKAGING	REMARKS	PACKAGE FORM
TSFF5210	Bulk	MOQ: 4000 pcs, 4000 pcs/bulk	T-1 $\frac{3}{4}$

**Note**

MOQ: minimum order quantity

### ABSOLUTE MAXIMUM RATINGS

PARAMETER	TEST CONDITION	SYMBOL	VALUE	UNIT
Reverse voltage		$V_R$	5	V
Forward current		$I_F$	100	mA
Peak forward current	$t_p/T = 0.5, t_p = 100 \mu s$	$I_{FM}$	200	mA
Surge forward current	$t_p = 100 \mu s$	$I_{FSM}$	1	A
Power dissipation		$P_V$	180	mW

<b>ABSOLUTE MAXIMUM RATINGS</b>				
PARAMETER	TEST CONDITION	SYMBOL	VALUE	UNIT
Junction temperature		$T_j$	100	°C
Operating temperature range		$T_{amb}$	- 40 to + 85	°C
Storage temperature range		$T_{stg}$	- 40 to + 100	°C
Soldering temperature	$t \leq 5$ s, 2 mm from case	$T_{sd}$	260	°C
Thermal resistance junction/ambient	J-STD-051, leads 7 mm, soldered on PCB	$R_{thJA}$	230	K/W

**Note**

$T_{amb} = 25$  °C, unless otherwise specified

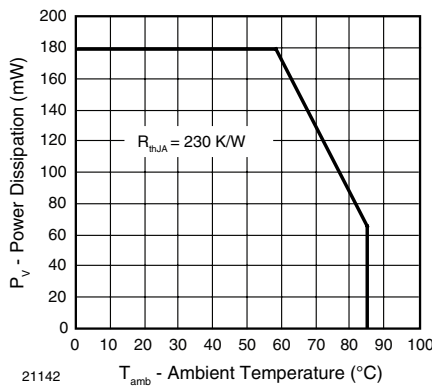


Fig. 1 - Power Dissipation Limit vs. Ambient Temperature

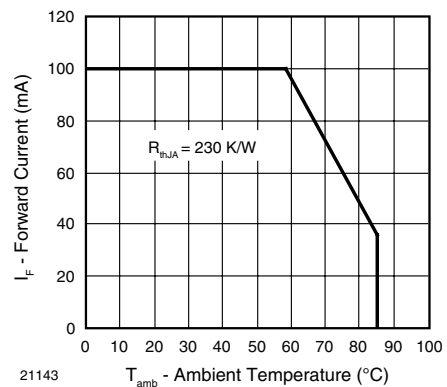


Fig. 2 - Forward Current Limit vs. Ambient Temperature

<b>BASIC CHARACTERISTICS</b>						
PARAMETER	TEST CONDITION	SYMBOL	MIN.	TYP.	MAX.	UNIT
Forward voltage	$I_F = 100$ mA, $t_p = 20$ ms	$V_F$		1.5	1.8	V
	$I_F = 1$ A, $t_p = 100$ $\mu$ s	$V_F$		2.3	3.0	V
Temperature coefficient of $V_F$	$I_F = 1$ mA	$TK_{V_F}$		- 1.8		mV/K
Reverse current	$V_R = 5$ V	$I_R$			10	$\mu$ A
Junction capacitance	$V_R = 0$ V, $f = 1$ MHz, $E = 0$	$C_j$		125		pF
Radiant intensity	$I_F = 100$ mA, $t_p = 20$ ms	$I_e$	120	180	360	mW/sr
	$I_F = 1$ A, $t_p = 100$ $\mu$ s	$I_e$		1800		mW/sr
Radiant power	$I_F = 100$ mA, $t_p = 20$ ms	$\phi_e$		50		mW
Temperature coefficient of $\phi_e$	$I_F = 100$ mA	$TK_{\phi_e}$		- 0.35		%/K
Angle of half intensity		$\phi$		$\pm 10$		deg
Peak wavelength	$I_F = 100$ mA	$\lambda_p$		870		nm
Spectral bandwidth	$I_F = 100$ mA	$\Delta\lambda$		40		nm
Temperature coefficient of $\lambda_p$	$I_F = 100$ mA	$TK_{\lambda_p}$		0.25		nm/K
Rise time	$I_F = 100$ mA	$t_r$		15		ns
Fall time	$I_F = 100$ mA	$t_f$		15		ns
Cut-off frequency	$I_{DC} = 70$ mA, $I_{AC} = 30$ mA pp	$f_c$		24		MHz
Virtual source diameter		$d$		3.7		mm

**Note**

$T_{amb} = 25$  °C, unless otherwise specified

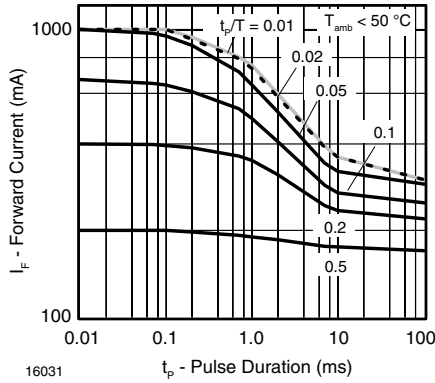
**BASIC CHARACTERISTICS**
 $T_{amb} = 25\text{ }^{\circ}\text{C}$ , unless otherwise specified


Fig. 3 - Pulse Forward Current vs. Pulse Duration

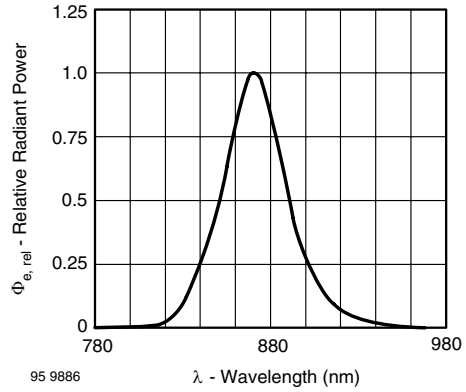


Fig. 6 - Relative Radiant Power vs. Wavelength

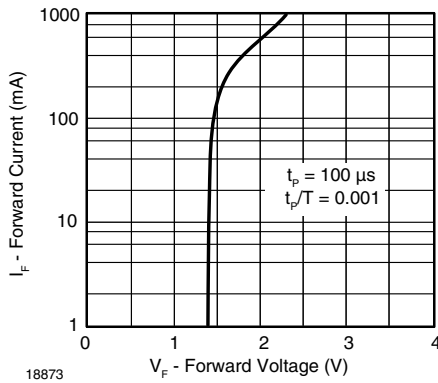


Fig. 4 - Forward Current vs. Forward Voltage

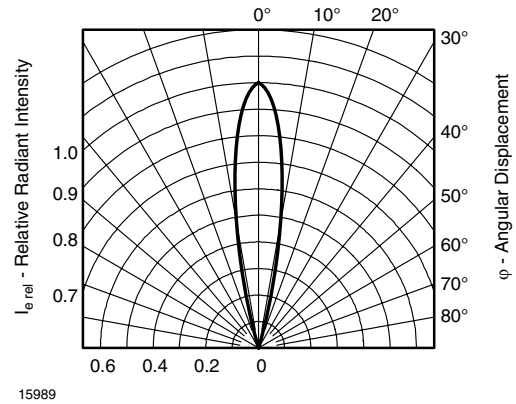


Fig. 7 - Relative Radiant Intensity vs. Angular Displacement

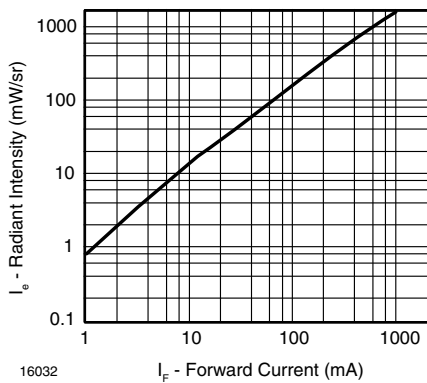


Fig. 5 - Radiant Intensity vs. Forward Current

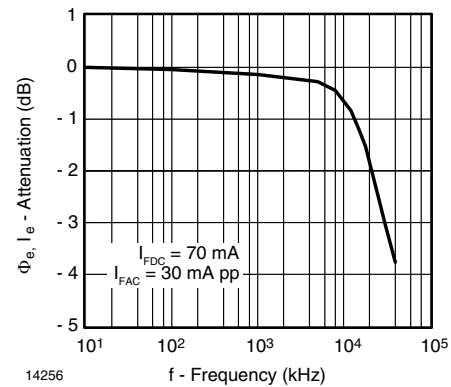


Fig. 8 - Attenuation vs. Frequency

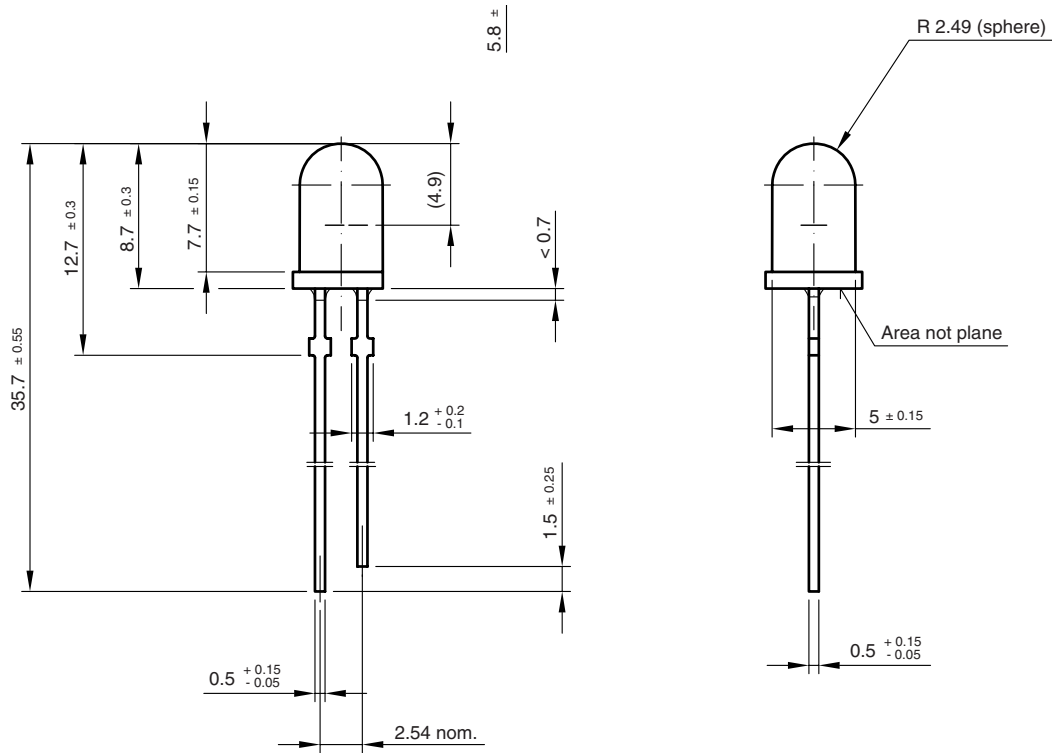
# TSFF5210

Vishay Semiconductors

High Speed Infrared Emitting Diode, RoHS Compliant, 870 nm, GaAlAs Double Hetero



## PACKAGE DIMENSIONS in millimeters



6.544-5258.09-4  
Issue: 2; 08.11.99  
15909



## Disclaimer

All product specifications and data are subject to change without notice.

Vishay Intertechnology, Inc., its affiliates, agents, and employees, and all persons acting on its or their behalf (collectively, "Vishay"), disclaim any and all liability for any errors, inaccuracies or incompleteness contained herein or in any other disclosure relating to any product.

Vishay disclaims any and all liability arising out of the use or application of any product described herein or of any information provided herein to the maximum extent permitted by law. The product specifications do not expand or otherwise modify Vishay's terms and conditions of purchase, including but not limited to the warranty expressed therein, which apply to these products.

No license, express or implied, by estoppel or otherwise, to any intellectual property rights is granted by this document or by any conduct of Vishay.

The products shown herein are not designed for use in medical, life-saving, or life-sustaining applications unless otherwise expressly indicated. Customers using or selling Vishay products not expressly indicated for use in such applications do so entirely at their own risk and agree to fully indemnify Vishay for any damages arising or resulting from such use or sale. Please contact authorized Vishay personnel to obtain written terms and conditions regarding products designed for such applications.

Product names and markings noted herein may be trademarks of their respective owners.